

## CAPITOLATO SEZIONALE FREEBOX

Perego S.r.l. - Via Primo Stucchi,78 - 20872 Cornate d'Adda (MB) Italia - Sede legale : Corso Sommelier,23 - 10128 Torino ( TO ) Italia - Codice Fiscale 00352230130 - Partita IVA 02485030130  
 Tel. +39.039.51.27.03 (r.a.) - Fax +39.039.951.51.98 info@peregosl.it - www.portoniperego.com - Società sottoposta ad attività di direzione e coordinamento da parte di Dierre S.p.A.

Versione 1/20

### PORTONE SEZIONALE FREEBOX CON MOLLE A TORSIONE

Apertura manuale, bilanciata tramite albero a molle di torsione.

Guide di scorrimento orizzontali doppie per funzionamento manuale e automatico, in acciaio zincato.

Rotelle di scorrimento doppie in nylon con cuscinetto.

Porta rotelle a filo pannelli e paracadute molle.

Pannelli altezza 500 mm coibentati con schiuma poliuretanic sp. 40 mm in acciaio zincato sendzimir secondo EN 10143 e EN 10346 preverniciato secondo EN 10169 con rivestimento in poliestere. Coibentazione con schiuma poliuretanic esente da CFC e HCFC con la capacità di conservare un alto contenuto di celle chiuse > 95% ( anigroscopico/antimuffa).

Tamburi in alluminio pressofusi e scanalati per cavo in acciaio.

Sistema di scorrimento compatto max ingombro architrave 210 mm ( per versione a molle anteriore ) o 170 mm ( per versione a molle posteriori ) o 350 mm ( per versione guide inclinate ).

**Nuova maniglia** di presa ovale nera incassata sul primo pannello o su riquadro su primo pannello ( per versione cassettato ).

Pomolo e mostrina di presa in zama verniciata a polvere nera con catarifrangente sul secondo pannello di serie su versione manuale o extra su versione motorizzata.

Per porte manuali è **OBBLIGATORIA** l'applicazione della serratura.

Spedizione in cassa di cartone e termoretraibile.

A richiesta : motorizzazione a traino completa di radiocomando e fotocellule ( no su tutte le versioni ) o montata lateralmente su albero di torsione o finestrate, griglie nel battente e portina pedonale nel battente o esterna alla porta sezionale.

Accessoristica a richiesta presente a listino in vigore.

LE REALIZZAZIONI

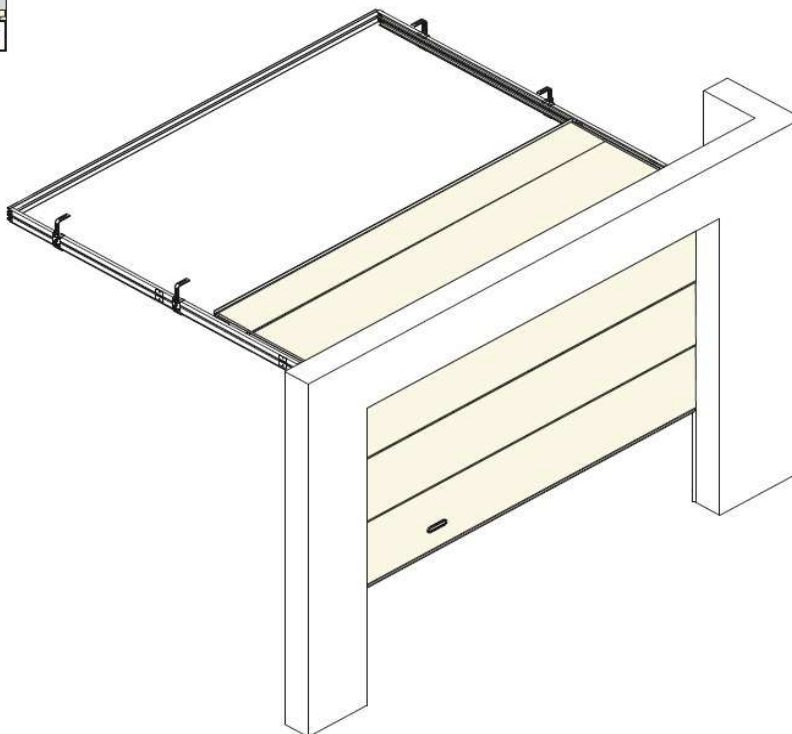

# CAPITOLATO SEZIONALE FREEBOX

Perego S.r.l. - Via Primo Stucchi,78 - 20872 Cornate d'Adda (MB) Italia - Sede legale : Corso Sommelier,23 - 10128 Torino ( TO ) Italia - Codice Fiscale 00352230130 - Partita IVA 02485030130  
 Tel. +39.039.51.27.03 (r.a.) - Fax +39.039.951.51.98 info@peregosl.it - www.portoniperego.com - Società sottoposta ad attività di direzione e coordinamento da parte di Dierre S.p.A.

Versione 1/20

## MODELLI E FINITURE

### MODELLO BASIC

**Superficie esterna:**

Goffrata legno, con 4 nervature, colore bianco Ral 9010 resistente ai raggi UV.

**Superficie interna:**

Goffrata stucco, con 4 nervature, colore bianco.

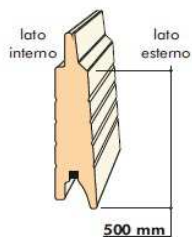

DISPONIBILE ANCHE RAL A SCELTA

### MODELLO DB

**Superficie esterna:**

Goffrata legno, con 1 nervatura centrale 20x5, colore bianco Ral 9010 resistente ai raggi UV.

**Superficie interna:**

Goffrata stucco, con 4 nervature, colore bianco.

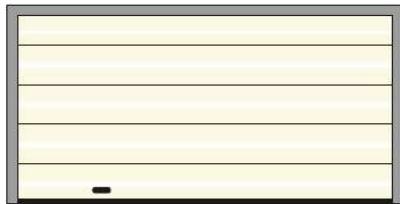
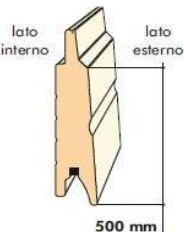

DISPONIBILE ANCHE RAL A SCELTA

### MODELLO L

**Superficie esterna:**

Goffrata legno, senza nervature, colore bianco Ral 9010 resistente ai raggi UV.

**Superficie interna:**

Goffrata stucco, con 4 nervature, colore bianco.

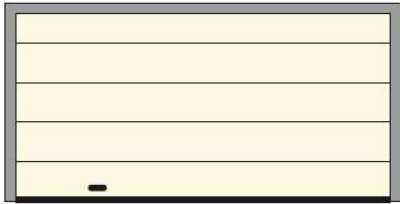
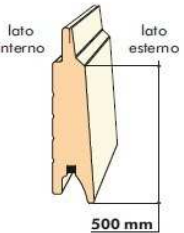

DISPONIBILE ANCHE RAL A SCELTA

### MODELLO LV

**Superficie esterna:**

Goffrata legno, senza nervature, colore verde Ral 6005 resistente ai raggi UV.

**Superficie interna:**

Goffrata stucco, con 4 nervature, colore bianco.

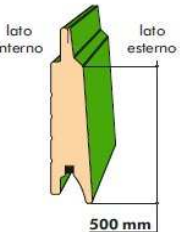

### MODELLO DGC

**Superficie esterna:**

Goffrata legno, con 1 nervatura centrale 20x5, colore ral 9006 resistente ai raggi UV.

**Superficie interna:**

Goffrata stucco, con 4 nervature, colore bianco.

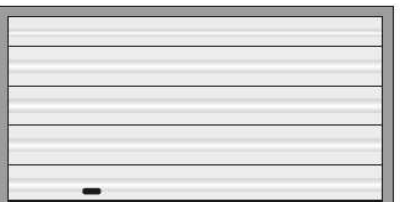
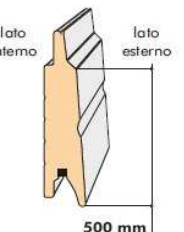

## CAPITOLATO SEZIONALE FREEBOX

Perego S.r.l. - Via Primo Stucchi,78 - 20872 Cornate d'Adda (MB) Italia - Sede legale : Corso Sommelier,23 - 10128 Torino ( TO ) Italia - Codice Fiscale 00352230130 - Partita IVA 02485030130  
 Tel. +39.039.51.27.03 (r.a.) - Fax +39.039.951.51.98 info@peregosl.it - www.portoniperego.com - Società sottoposta ad attività di direzione e coordinamento da parte di Dierre S.p.A.

Versione 1/20

### MODELLI E FINITURE

#### MODELLO DGS

**Superficie esterna:**

Goffrata legno, con 1 nervatura centrale 20x5, colore ral 9007 resistente ai raggi UV.

**Superficie interna:**

Goffrata stucco, con 4 nervature, colore bianco.

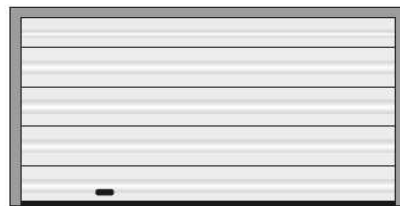
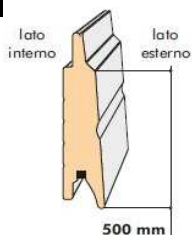

#### MODELLO TL

**Superficie esterna:**

Liscia, senza nervature, colore bianco Ral 9010 resistente ai raggi UV.

**Superficie interna:**

Goffrata stucco, con 4 nervature, colore bianco.

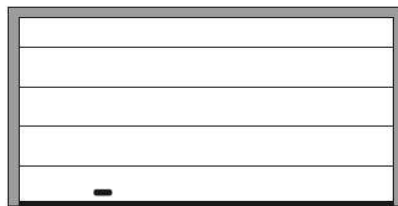
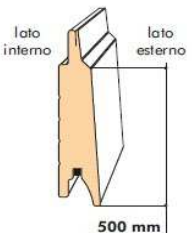

#### MODELLO SC

**Superficie esterna:**

Liscia, senza nervature, finitura effetto pietra di colore grigio chiaro resistente ai raggi UV.

**Superficie interna:**

Goffrata stucco, con 4 nervature, colore bianco.

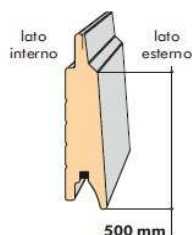

### In fase di ordinativo specificare SEMPRE il tipo di RAL d'interesse

#### MODELLO BL

**Superficie esterna:**

Senza nervature, solo per laccatura Ral finitura sabbata ( testurizzata ).

**Superficie interna:**

Goffrata stucco, con 4 nervature, colore bianco.

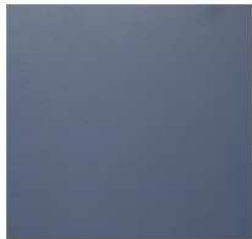
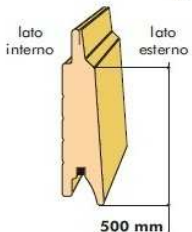

#### MODELLO CB

**Superficie esterna:**

Goffrata legno, con specchiature 507 x 340, colore bianco Ral 9010 resistente ai raggi UV.

**Superficie interna:**

Goffrata stucco, con 4 nervature, colore bianco.

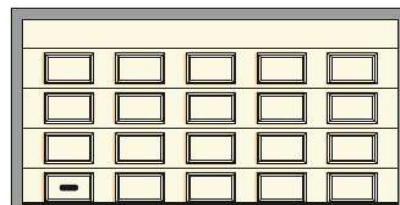
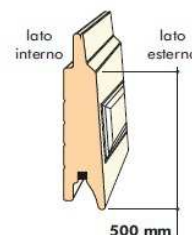

DISPONIBILE ANCHE RAL A SCELTA

## CAPITOLATO SEZIONALE FREEBOX

Perego S.r.l. - Via Primo Stucchi,78 - 20872 Cornate d'Adda (MB) Italia - Sede legale : Corso Sommelier,23 - 10128 Torino ( TO ) Italia - Codice Fiscale 00352230130 - Partita IVA 02485030130  
 Tel. +39.039.51.27.03 (r.a.) - Fax +39.039.951.51.98 info@peregosl.it - www.portoniperego.com - Società sottoposta ad attività di direzione e coordinamento da parte di Dierre S.p.A.

Versione 1/20

### MODELLI E FINITURE

#### MODELLO RLC

##### Superficie esterna:

Verniciato effetto legno, senza nervature, color simil legno chiaro resistenti ai raggi UV 10 anni.

##### Superficie interna:

Goffrata stucco, con 4 nervature, colore bianco.

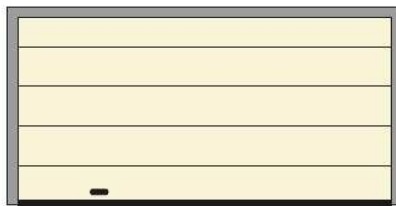
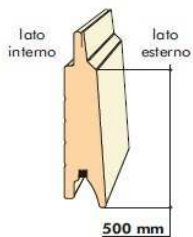

**GARANZIA**  
agli agenti  
atmosferici



#### MODELLO RLS

##### Superficie esterna:

Verniciato effetto legno, senza nervature, color simil legno scuro resistenti ai raggi UV 10 anni.

##### Superficie interna:

Goffrata stucco, con 4 nervature, colore bianco.

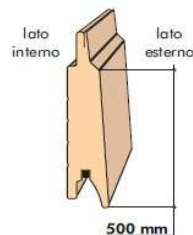

**GARANZIA**  
agli agenti  
atmosferici



#### MODELLO RDLC

##### Superficie esterna:

Verniciato effetto legno, con 1 nervatura centrale 20x5, color simil legno chiaro resistenti ai raggi UV.

##### Superficie interna:

Goffrata stucco, con 4 nervature, colore bianco.

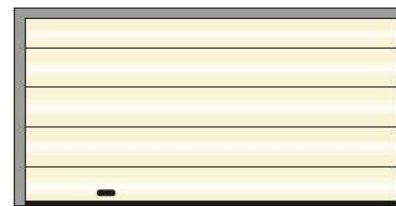
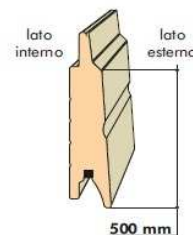

**GARANZIA**  
agli agenti  
atmosferici



#### MODELLO RDLS

##### Superficie esterna:

Verniciato effetto legno, con 1 nervatura centrale 20x5, color simil legno scuro resistenti ai raggi UV.

##### Superficie interna:

Goffrata stucco, con 4 nervature, colore bianco.

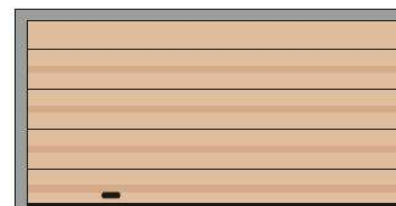
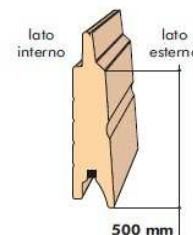

**GARANZIA**  
agli agenti  
atmosferici



#### MODELLO R1LC

##### Superficie esterna:

Verniciato effetto legno, con 4 nervature, color simil legno chiaro resistenti ai raggi UV.

##### Superficie interna:

Goffrata stucco, con 4 nervature, colore bianco.

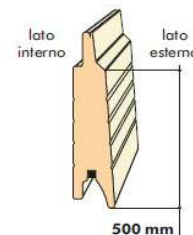

**GARANZIA**  
agli agenti  
atmosferici



## CAPITOLATO SEZIONALE FREEBOX

Perego S.r.l. - Via Primo Stucchi,78 - 20872 Cornate d'Adda (MB) Italia - Sede legale : Corso Sommelier,23 - 10128 Torino ( TO ) Italia - Codice Fiscale 00352230130 - Partita IVA 02485030130  
 Tel. +39.039.51.27.03 (r.a.) - Fax +39.039.951.51.98 info@peregosl.it - www.portoniperego.com - Società sottoposta ad attività di direzione e coordinamento da parte di Dierre S.p.A.

Versione 1/20

### MODELLI E FINITURE

#### MODELLO R1LS

##### Superficie esterna:

Verniciato effetto legno, con 4 nervature, color simil legno scuro resistenti ai raggi UV.

##### Superficie interna:

Goffrata stucco, con 4 nervature, colore bianco.

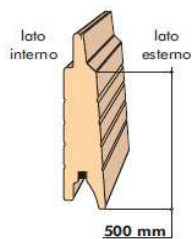

## CAPITOLATO SEZIONALE FREEBOX

Perego S.r.l. - Via Primo Stucchi,78 - 20872 Cornate d'Adda (MB) Italia - Sede legale : Corso Sommelier,23 - 10128 Torino ( TO ) Italia - Codice Fiscale 00352230130 - Partita IVA 02485030130  
 Tel. +39.039.51.27.03 (r.a.) - Fax +39.039.951.51.98 info@peregosl.it - www.portoniperego.com - Società sottoposta ad attività di direzione e coordinamento da parte di Dierre S.p.A.

Versione 1/20

### REALIZZAZIONI



### REALIZZAZIONI



**MOTORIZZAZIONI**

<b>Bft</b>				
 Telecomando Remote control	 Lampeggiante di sicurezza Safety flashing light	 Selettore apertura chiave dall'esterno Key opening selector from the outside	 Tastiera esterna per apertura con codice External keyboard for opening with code	 Motorizzazione basculante con sblocca motore Up and over door motor with motor release
 Telecomando BFT DIERRE BFT DIERRE remote control	 Motorizzazione per FREEBOX laterale su oilero molle Motor system for FREEBOX lateral on sprung shaft	 Lettore Key Card e Key Control compatibile con porta blindata Dierre Bietra Key Card and Key Control reader compatible with Dierre Bietra security door	 Garage Door Pass con sensore di prossimità Garage Door Pass With proximity sensor	 Motore a traino per FREEBOX Pull motor for FREEBOX
<b>FAAC</b>				
 Motore FAAC basculante FAAC motor up and over door	 Telecomando FAAC DIERRE FAAC DIERRE remote control	 Motore a traino per FREEBOX Pull motor for FREEBOX	 Lettore Key Card e Key Control compatibile con porta blindata Dierre Bietra Key Card and Key Control reader compatible with Dierre Bietra security door	 Tastiera esterna per apertura con codice External keyboard for code opening
 Lampeggiante di sicurezza Safety flashing light	 Kit GSM per iPhone Remote Control GSM kit for iPhone Remote Control	 Selettore apertura chiave dall'esterno Key opening selector from the outside	 Fotocellule di sicurezza Safety photocells	
<b>novità SOLO PER FREEBOX ONLY FOR FREEBOX</b>		<b>SOMMER</b>		
 Motore sezionale SOMMER SOMMER sectional motor	 Fotocellule di sicurezza SOMMER SOMMER Safety photocells	 Telecomando SOMMER DIERRE SOMMER DIERRE remote control	 Selettore a chiave SOMMER SOMMER key selector	 Kit di sicurezza anti effrazione SOMMER SOMMER burglar-proof security kit

**novità**  
**Dr-Control**  
 Semplice. Pratico. Moderno.

Apri una porta per garage e il cancello con lo smartphone



Lettore di impronta digitale Fingerprint reader



Key Control e Key Card